



# Product Portfolio

Confidence. When Results Matter™

# OPTICAL GAGING PRODUCT (OGP) FAMILIES

**SMARTSCOPE | FLEXPPOINT | FUSION | ADVANCED PRODUCTION SYSTEMS**



## TURNCHECK



## CONTOUR PROJECTORS



## SHAPEGRABBER



## SNAP





**C-VISION**



**STARLITE**





ZIP

















The last 75 years have brought forth many technological innovations in the world of dimensional metrology for advanced manufacturers and established OGP<sup>®</sup> as the global leader in the market.



# CONTENTS

INTRODUCTION	6
COMPANY PROFILE – AT A GLANCE	8
MULTISENSOR MEASUREMENTS – SMARTSCOPE E-SERIES	10
MULTISENSOR MEASUREMENTS – SMARTSCOPE FLASH	12
MULTISENSOR MEASUREMENTS – SMARTSCOPE ZIP	14
MULTISENSOR MEASUREMENTS – SMARTSCOPE SP	16
MULTISENSOR MEASUREMENTS – SMARTSCOPE QUEST	18
ADVANCED PRODUCTION SYSTEMS – BENCHMARK   PINNACLE   SUMMIT	20
MULTISENSOR MEASUREMENT SYSTEMS – FUSION	22
MULTISENSOR MEASUREMENT SYSTEMS – FLEXPOINT	24
SENSORS AND PROBES	26
SHAFT MEASUREMENT SYSTEMS – TURNCHECK	28
3D LASER SCANNING SYSTEMS – SHAPEGRABBER	30
CONTOUR PROJECTORS – FOCUS   QL-20	32
VIDEO CONTOUR PROJECTORS – C-VISION	34
2D LARGE FIELD-OF-VIEW VIDEO MEASUREMENT SYSTEMS – SNAP	36
SEMI-AUTOMATIC ZOOM VIDEO MEASUREMENT SYSTEM – STARLITE	38
SPECIALIZED SYSTEMS – FLEXGAUGE   LAZER   COBRA	40
METROLOGY SOFTWARE – ZONE3	42
EVALUATION SOFTWARE – EVOLVE	44
GLOBAL SERVICE AND SUPPORT	45
THE OGP PRODUCT FAMILY	46
ADDITIONAL INFORMATION ABOUT OGP SYSTEMS	48

## ICONOLOGY

OPTICAL SENSORS/ACCESSORIES	TACTILE PROBES	LASER SENSORS
Video Sensors 	Articulating Probe Head 	DRS™ Laser 
Grid Projector 	Feather™ Probe 	Rainbow™ Probe 
Fixtures 	Scanning Probe 	TeleStar Plus (TTL) Laser 
Overlay Charts 	Touch Probe 	Through-the Lens (TTL) Laser 
Rotary Indexers 		TeleStar Probe 
		Line Scan Laser 

# INTRODUCTION



## Optical Gaging Products (OGP)

OGP (Optical Gaging Products) is a division of Quality Vision International Inc (QVI®), a world-leading manufacturer of precision multisensor metrology systems for industrial quality control since 1945. Our metrology systems focus on measurement technologies that help manufacturers monitor dimensional compliance to design specifications.

First introduced in 1991, our famous OGP SmartScope® product family has become one of the world's most popular and versatile dimensional measurement systems. SmartScope systems are designed and produced at QVI corporate headquarters in Rochester, NY, USA.

Today, OGP offerings have expanded to include shaft measurement systems and a line of innovative multisensor CMMs. OGP products also include 3D scanning systems and measuring systems with unique capabilities to support high volume production.

## Industries

With over 75 years of technical innovation for metrology, OGP is recognized worldwide as a customer trusted supplier of non-contact and multisensor dimensional measuring systems. In today's world, improved productivity is everyone's goal. OGP's innovative measurement technology provides precision for people – precision measurement systems designed for the people who use them. At OGP, we have decades of experience with supplied metrology solutions in relation to a variety of different industry applications.

### Aerospace



### Automotive



### Energy



### Manufacturing



### Medical

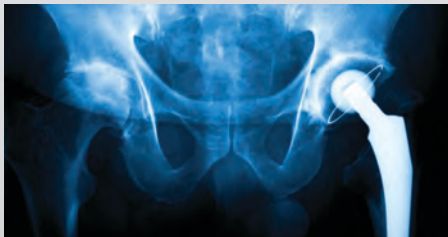

### Plastics





# 75+ Years of Transforming Dimensional Metrology

**1945**  
OGP is Founded  
77 years ago in Rochester, NY

**1956**  
Projectron™  
The first electronic edge detection system for optical comparators

**1980**  
Vidicom Qualifier  
First sub-pixel gray scale processing vision system

**1984**  
Vidiprobe Contour Projector®  
First video projector hybrid system

**1986**  
Intelligent Qualifier 2000  
First multisensor geometric feature extraction algorithm measurement system

**1991**  
SmartScope Launched  
Color video camera, digital overlay charts, and programmable zoom optics

**1994**  
AccuCentric® Innovation  
First self-calibrating zoom lens

**2000**  
SmartScope Flash™ Debut  
Elevating bridge design with embedded SmartRing™ Light surface illumination flexibility

**2002**  
TeleStar® Zoom Lens  
Telecentric 10:1 zoom lens introduced

**2010**  
TeleStar TTL Laser Launched  
First interferometric, long working distance, high accuracy, through-the-lens (TTL) laser

**2014**  
ZONE3® Metrology Software Introduced  
Comprehensive CAD based multisensor user experience

**2018**  
VersaFlex™  
Patented articulating all in one three sensor (Telecentric Video, Scanning Probe, and Interferometric Laser) probe head

# COMPANY PROFILE – AT-A-GLANCE

**OGP systems set the standard of video and multisensor excellence, and are used by leading manufacturers around the world, when confidence in results is of the utmost importance.**

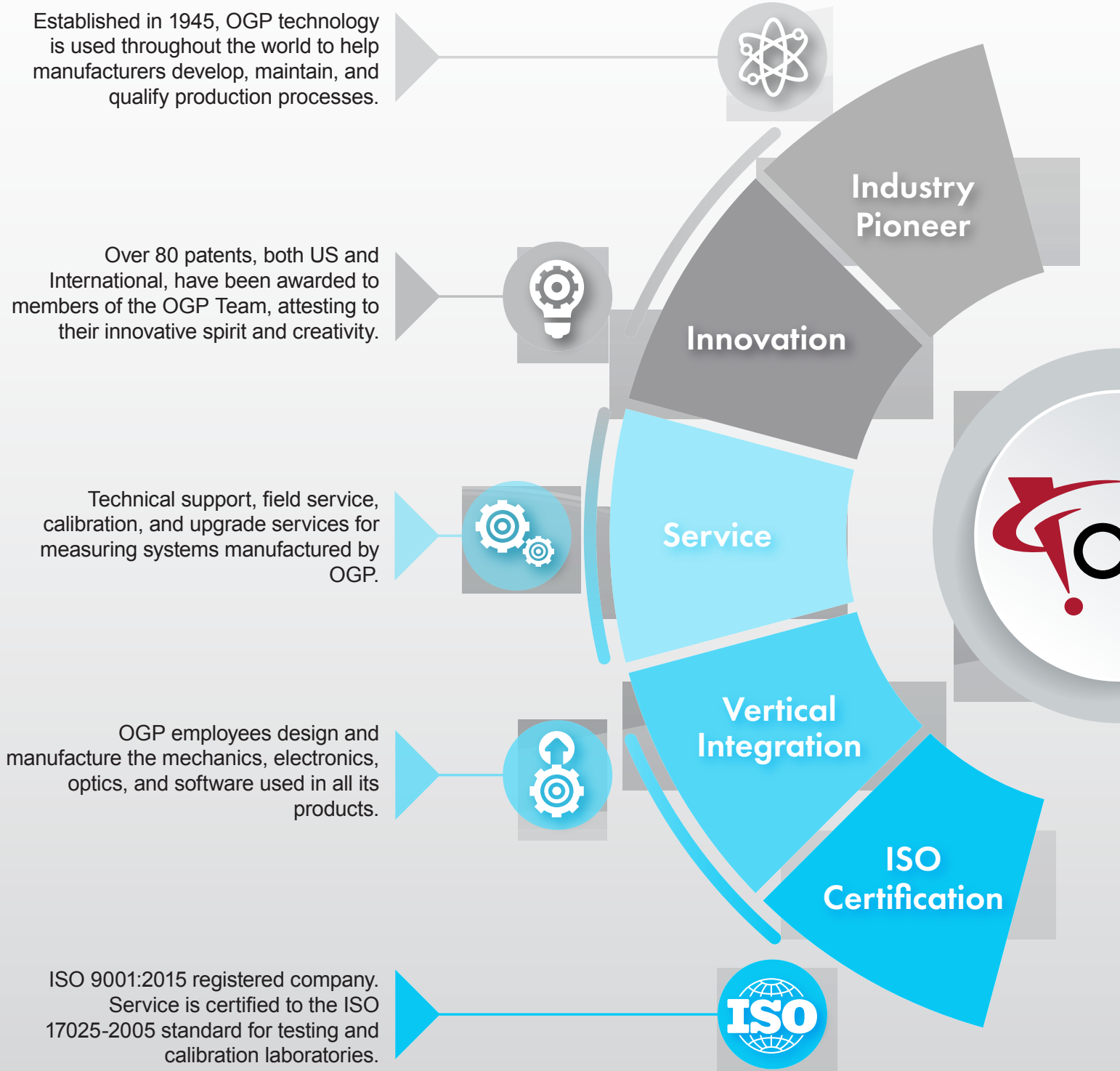



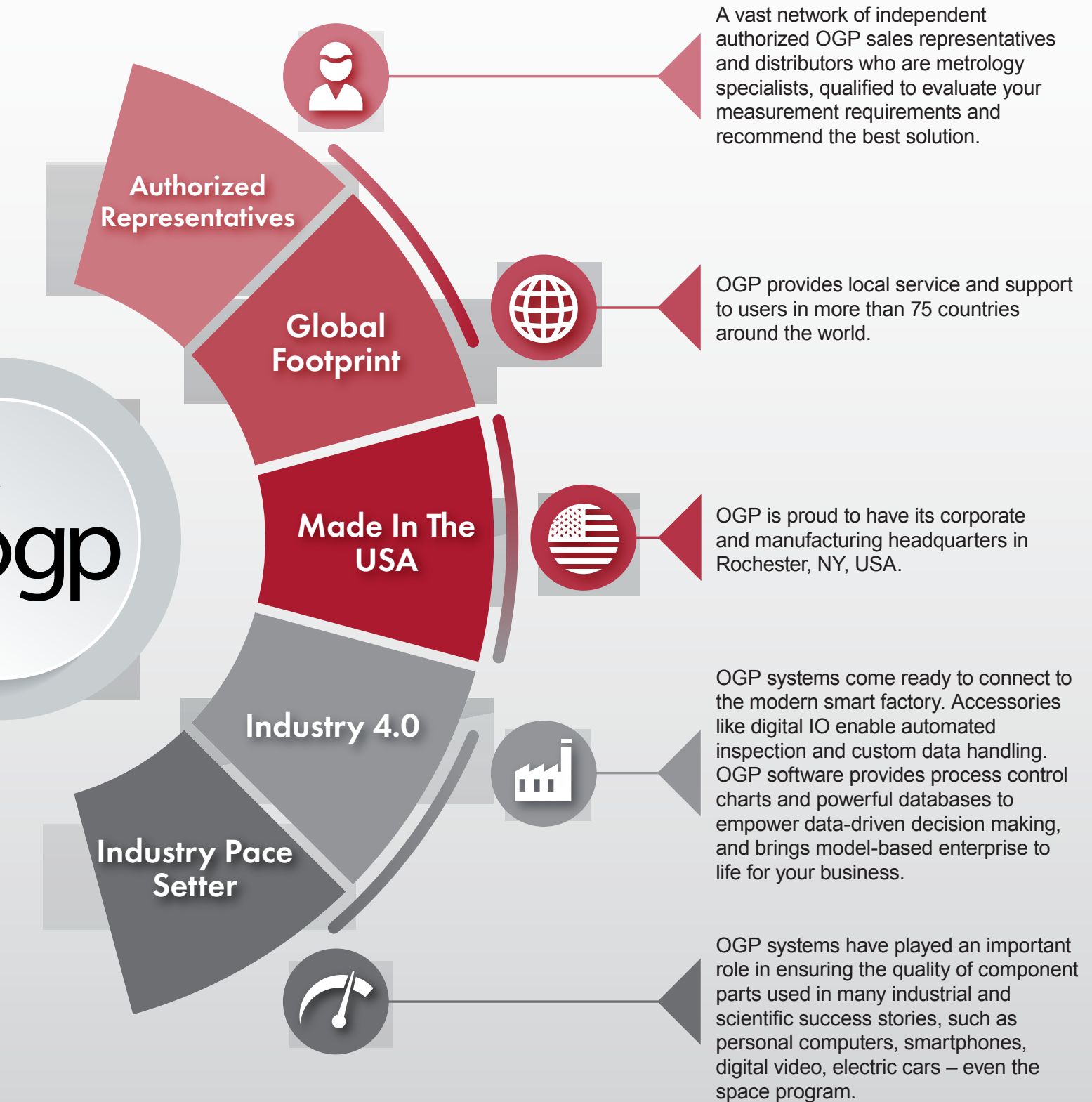

Automatic digital zoom metrology systems setting the standard for 3-axis video measurement.



# MULTISENSOR MEASUREMENTS – SMARTSCOPE

## SmartScope E-Series

**SmartScope E-Series** systems are automatic digital zoom metrology systems that set the standard for 3-axis video measurement performance. The IntelliCentric™ fixed lens optical system with 6-megapixel color camera and digital zoom provide a high-resolution image engineered for video edge detection metrology. All LED coaxial, substage profile, and SmartRing™ light illumination is standard.

### OPTICAL SENSORS/ACCESSORIES

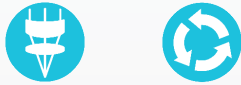

### TACTILE PROBES



*SmartScope E-Series systems offer many multisensor options. Visit [ogpnet.com/e-series](http://ogpnet.com/e-series) for details.*



SmartScope E7



SmartScope E45

## HIGHLIGHTS

### Programmable Rotary Indexers



### SmartRing

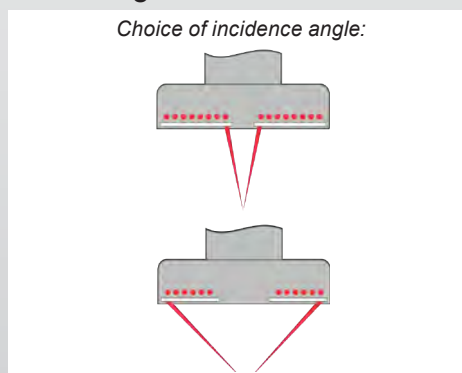

### Measure-X®

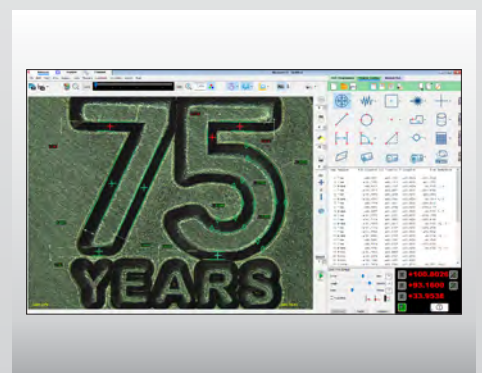

# MULTISENSOR MEASUREMENTS – SMARTSCOPE

The best choice in automatic general-purpose, coordinate measuring with multisensor dimensional measurement.

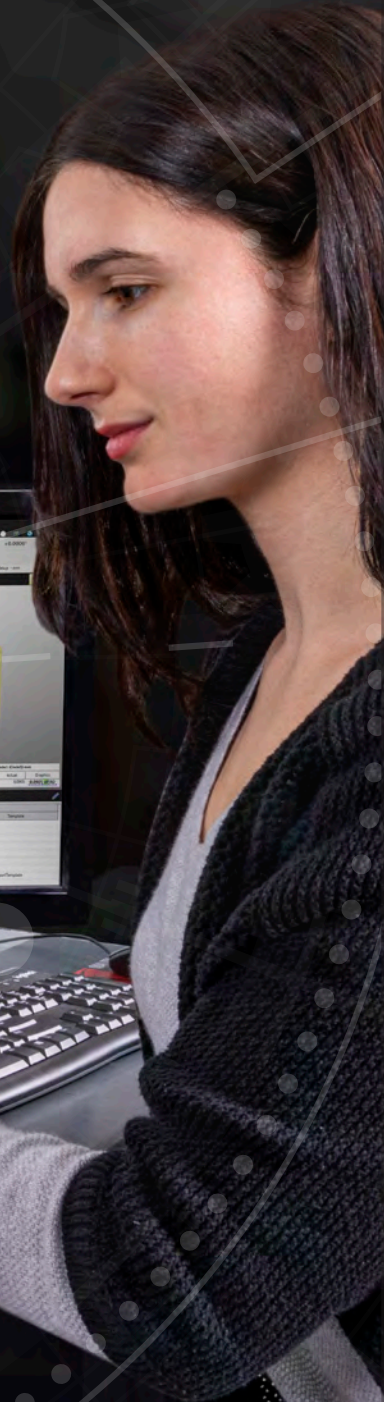
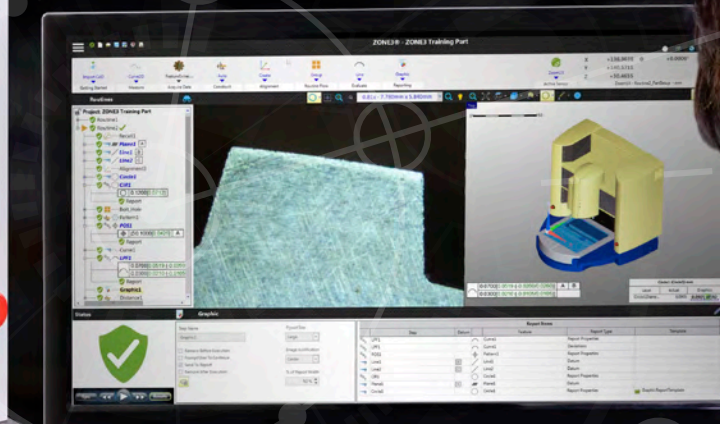



# MULTISENSOR MEASUREMENTS – SMARTSCOPE

## SmartScope Flash

SmartScope Flash™ systems from OGP are versatile multisensor measuring systems built to handle a wide variety of measurement tasks. Flash systems feature an ideal price-to-performance ratio and are extremely popular, with thousands in service worldwide. These systems include a motorized 12:1 zoom optical system and AccuCentric lens that auto-compensates after every magnification change. All LED coaxial, substage profile, and SmartRing light illumination is standard.

### OPTICAL SENSORS/ACCESSORIES



### TACTILE PROBES



### LASER SENSORS



SmartScope Flash systems offer many multisensor options. Visit [ogpnet.com/Flash](http://ogpnet.com/Flash) for details.



SmartScope Flash 200



SmartScope Flash 302



SmartScope Flash 500



SmartScope Flash 635



SmartScope Flash 670

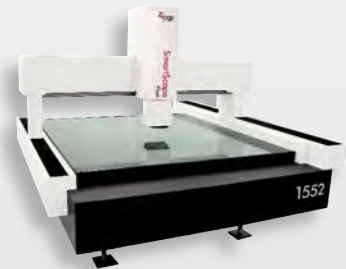

SmartScope Flash 1500|1550|1552

## HIGHLIGHTS

### TTL Laser

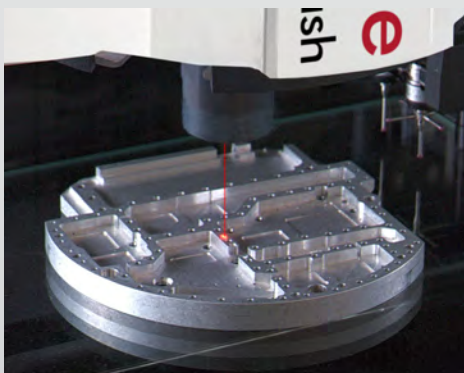

### AccuCentric Zoom Lens

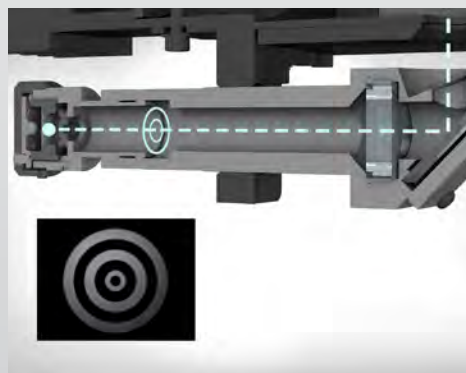

### Touch Probe



Capable, field-tested  
automatic dimensional  
measurement, worldwide  
favorites in the industrial  
marketplace.



# MULTISENSOR MEASUREMENTS – SMARTSCOPE

## SmartScope ZIP

SmartScope ZIP® systems offer superior optical performance and numerous sensor options for multisensor versatility. These systems feature a motorized 7:1 zoom optical system with a range of lens and back tube configurations to suit a wide variety of applications. The AccuCentric reticle auto-compensates the optics after every magnification change. All LED coaxial, substage profile, and SmartRing light illumination is standard.

ZIP HR 250 offers advanced imaging and illumination through a 5-megapixel monochrome digital camera and a programmable ring light (PRL) that provides the ability to automatically change the angle of incidence.

### OPTICAL SENSORS/ACCESSORIES



### TACTILE PROBES



### LASER SENSORS



SmartScope ZIP systems offer many multisensor options. Visit [ogpnet.com/ZIP](http://ogpnet.com/ZIP) for details.



SmartScope ZIP 250

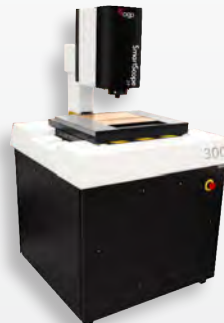

SmartScope ZIP 300



SmartScope ZIP 450

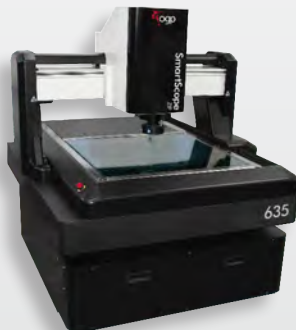

SmartScope ZIP 635



SmartScope ZIP 800



SmartScope ZIP HR 250

## HIGHLIGHTS

### Flexible Illumination

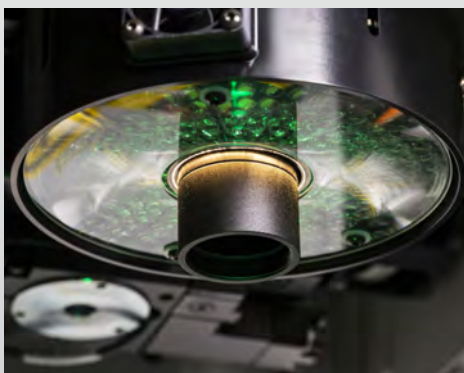

### Configurable Optics



### World's Most Popular SmartScope







High performance multisensor metrology systems designed for optimum scanning probe performance.



# MULTISENSOR MEASUREMENTS – SMARTSCOPE

## SmartScope SP

**SmartScope SP** systems are designed for maximum scanning probe performance with SP25 scanning probe included standard. Starting with a rigid base structure, the system mechanics are designed to optimize dynamic data acquisition critical to scanning probe performance. Most performance specifications for SP models are according to ISO 10360 standards. SP optics combine a wide field objective lens, digital zoom, and 5-megapixel monochrome digital camera, providing a distortion-free image at low zoom, with high resolution at high zoom. The AccuCentric reticle auto-compensates the optics after every magnification change. All LED coaxial, substage profile, and SmartRing light illumination is standard.

### OPTICAL SENSORS/ACCESSORIES



### TACTILE PROBES



### LASER SENSORS



*SmartScope SP systems offer many multisensor options. Visit [ogpnet.com/SP](http://ogpnet.com/SP) for details.*

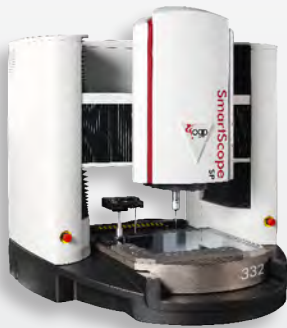

SmartScope SP 332



SmartScope SP 463



SmartScope SP 663

## HIGHLIGHTS

### Scanning Probe

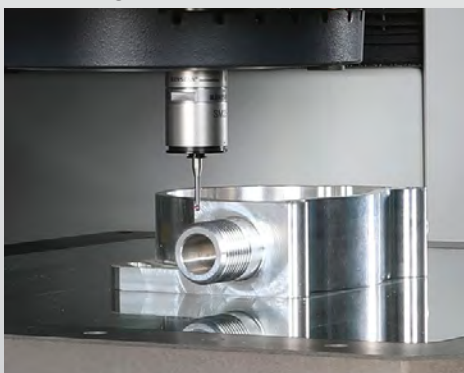

### Full ISO 10360 Compensation

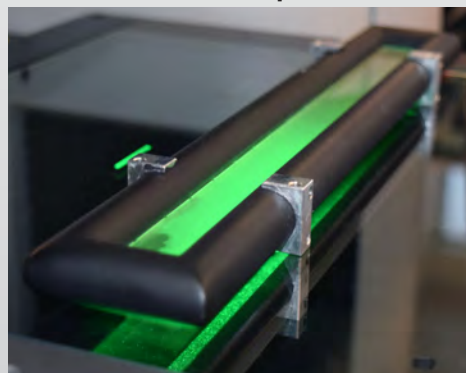

### Grid Projector





# MULTISENSOR MEASUREMENTS – SMARTSCOPE



High-accuracy systems designed to use a variety of sensors for full 3D measurement.



# MULTISENSOR MEASUREMENTS – SMARTSCOPE

## SmartScope Quest

SmartScope Quest™ systems are designed to provide the best performance and the highest accuracy in three-dimensional multisensor measurement. The TeleStar 10:1 zoom optical system offers the best optical performance of any zoom system offered by OGP. TeleStar optics are completely telecentric throughout their range, for distortion-free, high fidelity images – ideal for high accuracy measurement. The AccuCentric reticle auto-compensates the optics after every magnification change. All green LED coaxial, substage profile, and SmartRing light illumination is standard.

### OPTICAL SENSORS/ACCESSORIES



### TACTILE PROBES



### LASER SENSORS



SmartScope Quest systems offer many multisensor options. Visit [ogpnet.com/Quest](http://ogpnet.com/Quest) for details.



SmartScope Quest 250

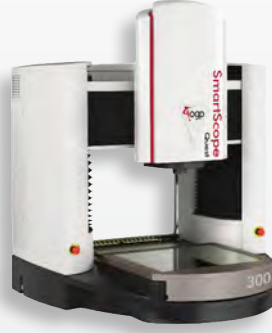

SmartScope Quest 300



SmartScope Quest 450



SmartScope Quest 650

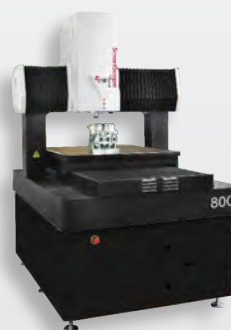

SmartScope Quest 800

## HIGHLIGHTS

### TeleStar Plus (TTL) Laser

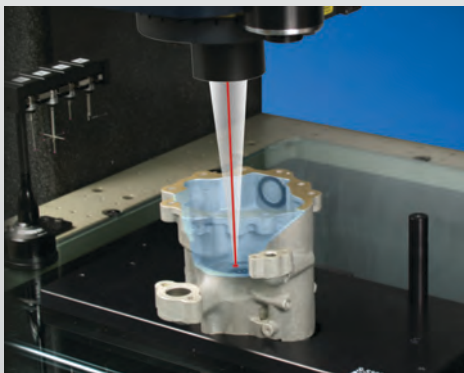

### Dual-Axis Rotary Indexers

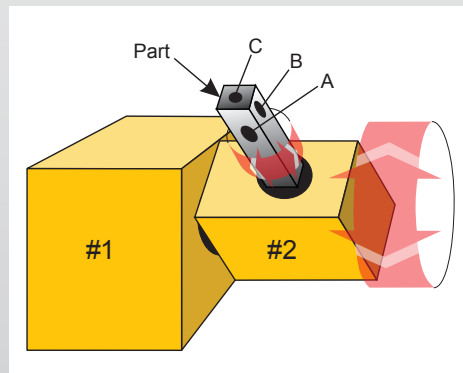

### Deployable Articulating PH10





Optical metrology systems tailored for wafer, photomask, slider, MEMS, semiconductor package, HDD suspension, probe card micro-component process measurements, and other critical dimensional measurement needs.



# ADVANCED PRODUCTION SYSTEMS

## Benchmark, Pinnacle, and Summit

**Benchmark™, Pinnacle™ and Summit™** systems combine high accuracy transport and optical technologies with advanced software and customized application support to satisfy the unique demands of process monitoring near the production line. These systems offer a choice between single or dual magnification fixed lens optical systems. All LED coaxial, substage profile, and Programmable Ring Light (PRL) illumination is standard. In addition to programmable intensity and direction of illumination, the PRL offers the ability to automatically change the angle of incidence and color of the illumination.

### OPTICAL SENSORS/ACCESSORIES



### TACTILE PROBES



### LASER SENSORS



*Advanced Production Systems offer many multisensor options. Visit [ogpnet.com/aps](http://ogpnet.com/aps) for details.*



**Benchmark**



**Pinnacle**



**Summit**

## HIGHLIGHTS

### Continuous Image Capture (CiC™) Strobing

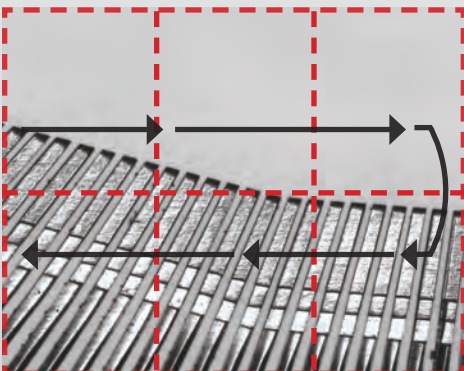

### Area Multi-Focus

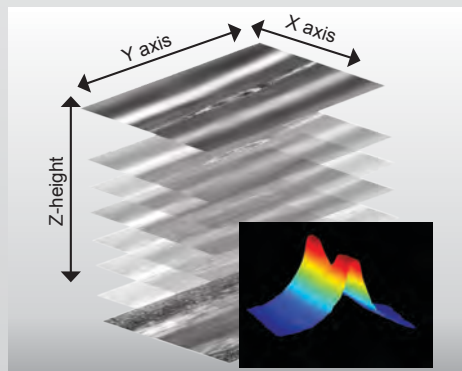

### Digital Megapixel Cameras

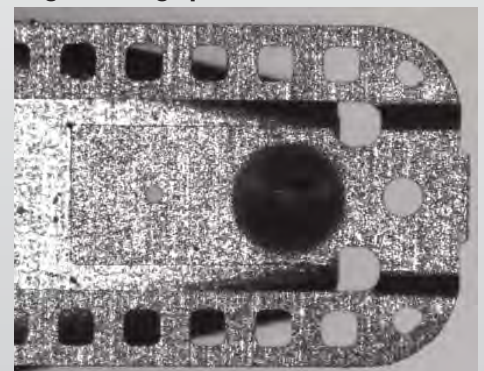



# MULTISENSOR MEASUREMENT SYSTEMS – FUSION

An innovative large field-of-view 3D multisensor measurement system that offers advanced large field image analysis capability.

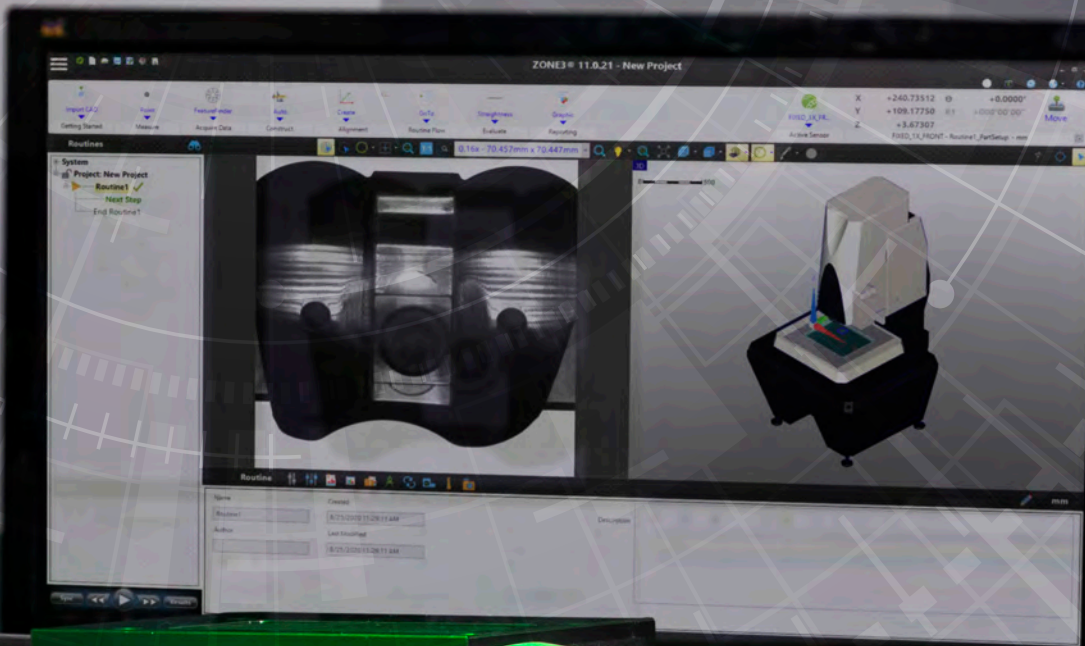



# MULTISENSOR MEASUREMENT SYSTEMS – FUSION

## Fusion

**Fusion** systems are innovative, high-speed, 3D multisensor measurement systems that combine an exceptional large field-of-view (LFOV) optical system with multisensor flexibility, to form a uniquely productive metrology system family.

The capability lies in the telecentric large field-of-view optics. Fusion offers dual optical magnifications: low with 100 mm viewing area, and high for small feature measurements and autofocus – each telecentric for image accuracy throughout the depth of field. Advanced design principles and FOV non-linear calibration allow Fusion systems to measure many features in a large FOV with the same accuracy as a small FOV on a traditional video measurement system. Large field optics allow a wide area to be imaged with high accuracy, while feature extraction can instantly process and identify all features and dimensions within the scene – with no need for a pre-programmed measurement routine.

### OPTICAL SENSORS/ACCESSORIES



### TACTILE PROBES



### LASER SENSORS



*Fusion systems offer many multisensor options. Visit [ogpnet.com/Fusion](http://ogpnet.com/Fusion) for details.*



Fusion 400



Fusion 600

## HIGHLIGHTS

Large Field of View Large Depth of Field 3D Measuring Platform



TeleStar TTL Laser

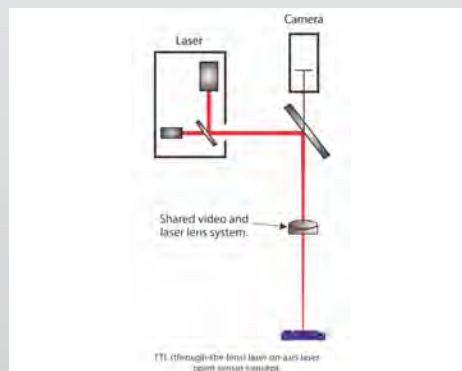

All Sensors on Axis via the Rotational Deployment Mechanism



A new generation of CMM with a unique combination of sensors, and CAD based programming, to solve a wide variety of dimensional measurement problems for large format parts.



# MULTISENSOR MEASUREMENT SYSTEMS – FLEXPPOINT

## FlexPoint

### Coordinate Measuring Systems with Multisensor Capabilities

FlexPoint® systems offer a unique combination of sensors, and CAD based programming, to solve a wide variety of dimensional measurement problems. FlexPoint features VersaFlex™ – the patented sensor array offering up to three simultaneously available sensors on an articulating head. Measure parts with trusted scanning probe, telecentric optics, and 1 µm accuracy TeleStar interferometric laser – without the downtime of exchanging sensors and constantly recalibrating.

#### OPTICAL SENSORS/ACCESSORIES



#### TACTILE PROBES



#### LASER SENSORS



FlexPoint systems offer many multisensor options. Visit [ogpnet.com/FlexPoint](http://ogpnet.com/FlexPoint) for details.



FlexPoint 7-Series



FlexPoint 9-Series



FlexPoint 12-Series

### PATENTED FEATURES

Articulating Three Sensor Head with Best in Class Telecentric Optics

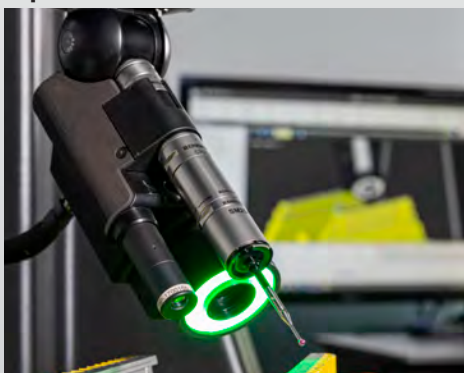

Shoulder Pocket Offers Additional Sensor Head Clearance



Best in Class Non-Contact Interferometric Point Sensor



## SENSORS AND PROBES

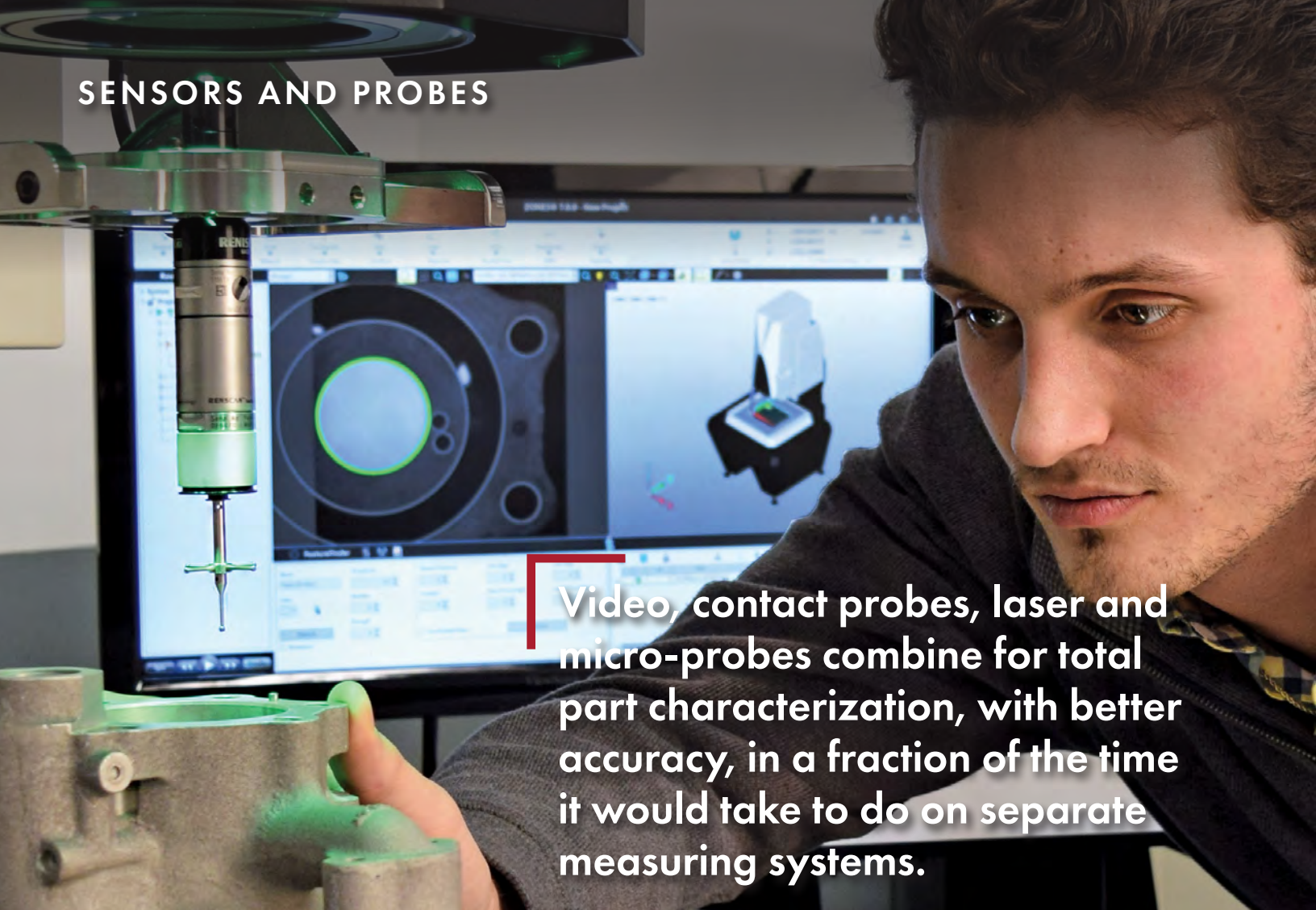

Video, contact probes, laser and micro-probes combine for total part characterization, with better accuracy, in a fraction of the time it would take to do on separate measuring systems.

## Why Multisensor?

Multisensor metrology systems offer significant advantages in measurement speed and accuracy. By using the best type of sensor for individual dimensions, multisensor systems measure parts faster, more thoroughly, and more accurately.

OGP SmartScope systems are designed as multisensor systems from the ground up. All sensors are integrated seamlessly with the system mechanics and software, simultaneously compensated and available for use at any step in the measurement routine.

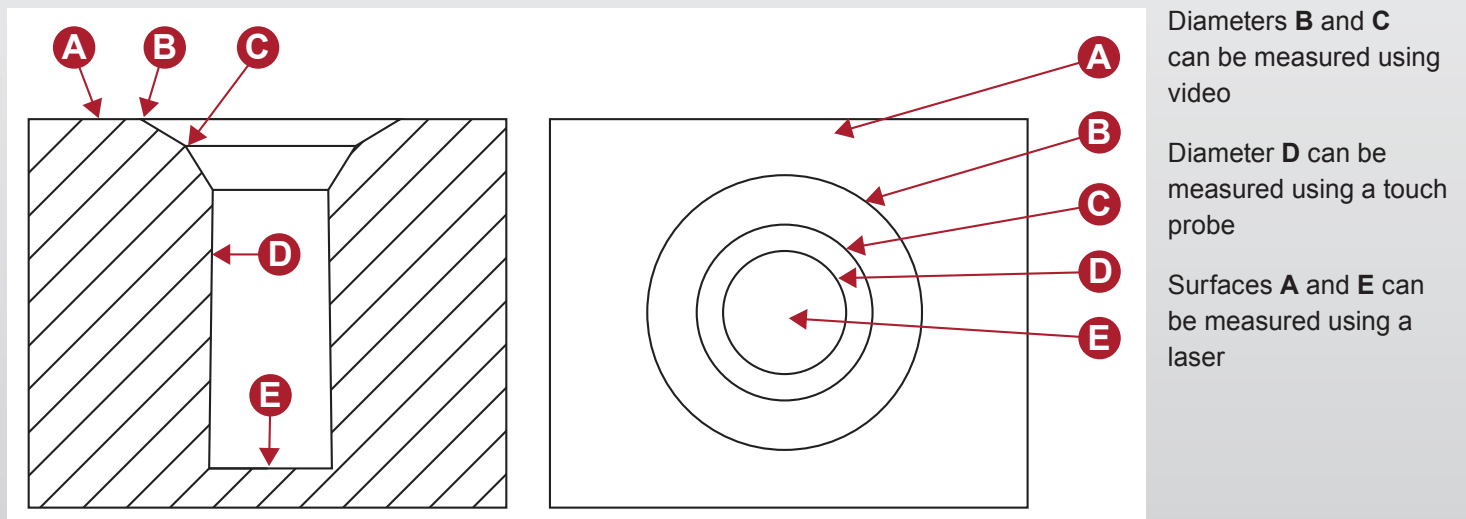



# The Multisensor Lineup

See Page 5 for Complete Icon Legend

## Video Sensors

Fast, non-contact video measurement, the core technology of SmartScope systems, provides high accuracy and repeatability for defined dimensions.

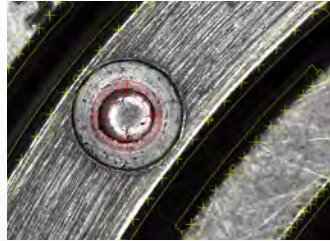

## Feather Probe™

Provides access to small features that are inaccessible to video measurement or conventional touch probes, or too sensitive to withstand traditional probing forces.



## Articulating Probe Head (PH10M PLUS)

For the ultimate in probing flexibility use either a touch trigger or scanning probe with a PH10M PLUS articulating head.



## Touch Probe (TP20/TP200)

Touch trigger contact probing allows for measurement of part surfaces that cannot be measured with optics or lasers.

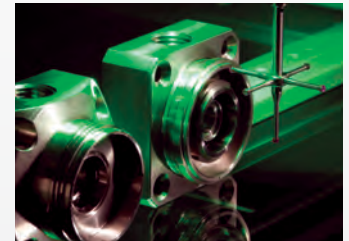

## Scanning Probe (SP25M)

Provides continuous contact scanning which offers high-speed data gathering on complex surfaces, large or small variations in surface contours.

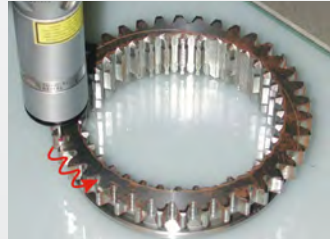

## Grid Projector

Grid Projector enables accurate autofocus on reflective surfaces for easy, fast focus – even on mirror polished metal.

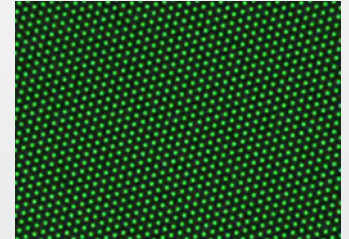

## Rotary Indexers (4th & 5th Axis)

Rotary indexers can be mounted together with their axis perpendicular to one another to add two axes of part positioning. The part under inspection is attached to the secondary rotary, which is mounted to the primary rotary.



## Triangulation Laser

These lasers excel at fast and accurate Z-axis point acquisition. Use a laser for height, depth and planar measurements, or for surface profiling on complex curves and surfaces.

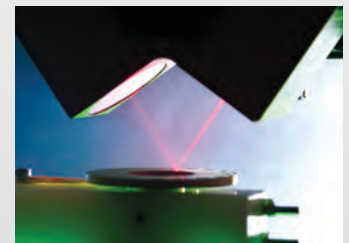

## Rainbow Probe

Rainbow Probe easily measures transparent, translucent, fragile, liquid or easily deformable surfaces and are mounted in mechanical deployment mechanisms so they can be retracted when not in use.

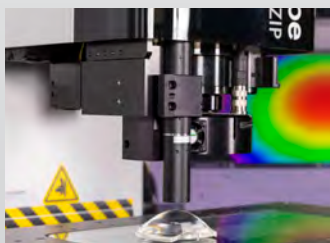

## TeleStar Interferometric Sensors

TeleStar Sensors offer sub-micron resolution, providing excellent performance on both specular and light-scattering diffuse surfaces. Sensors may be through-the-lens (TTL) or off-axis (TeleStar Probe).



## SHAFT MEASUREMENT SYSTEMS – TURNCHECK

Measure shafts, cylinders and other turned, ground, or extruded parts with speed and precision.

TurnCheck  
6/30



# SHAFT MEASUREMENT SYSTEMS – TURNCHECK

## TurnCheck

TurnCheck™ systems are designed to be placed on the shop floor with machine tools, to provide improved process control through immediate feedback. TurnCheck systems offer advanced, telecentric optics designed to produce distortion-free images of all types and finishes of shafts and cylinders, even in workshop conditions. A built-in light curtain safeguards the operator during automatic measurement.

### OPTICAL SENSORS/ACCESSORIES



Visit [ogpnet.com/TurnCheck](http://ogpnet.com/TurnCheck) for details.



TurnCheck Series-6



TurnCheck Series-10



TurnCheck Series-14

## HIGHLIGHTS

### Helix Option for True Thread Form Measurements

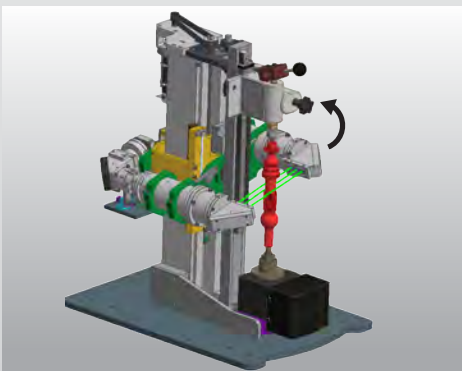

### Large Field of View Telecentric Optics

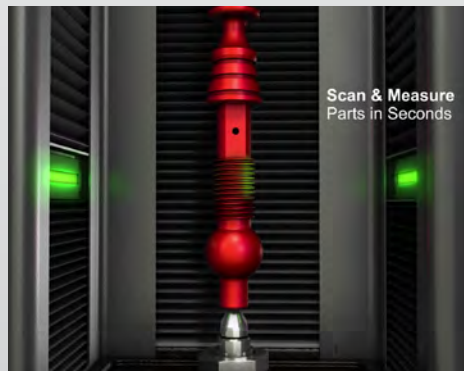

### Granite Base Support



## 3D LASER SCANNING SYSTEMS – SHAPEGRABBER

ShapeGrabber

ogp

Automated 3D scanners ideal for measuring complex-shaped parts where speed, complete coverage and ease-of-use are important.

ShapeC



# 3D LASER SCANNING SYSTEMS – SHAPEGRABBER

## ShapeGrabber

ShapeGrabber® 3D Laser systems deliver fast, accurate and automated 3D measurement. Using multiple motion axes, ShapeGrabber laser scanners are easily programmed for repetitive measurements and eliminate the need for software alignment and registration. All ShapeGrabber systems collect accurate, high density point data, and provide reports of results, including GD&T.

### OPTICAL SENSORS/ACCESSORIES



### LASER SENSORS



Visit [ogpnet.com/ShapeGrabber](http://ogpnet.com/ShapeGrabber) for details.

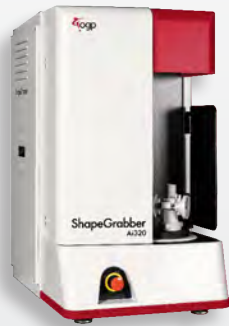

ShapeGrabber Ai320

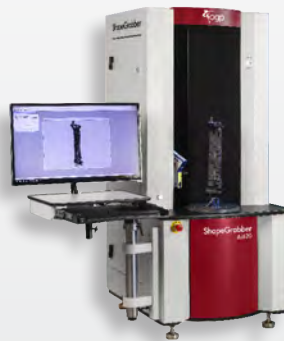

ShapeGrabber Ai620



ShapeGrabber Ai820

## HIGHLIGHTS

### Automatic Rotary Table

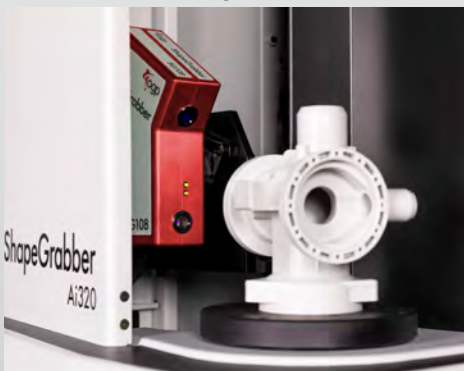

### Tilt Mechanism



### Multiple Laser Heads





# CONTOUR PROJECTORS – FOCUS | QL-20



Cutting-edge optics, lighting,  
and automation technologies  
for enhanced productivity  
and profitability.



## Contour Projectors

Contour Projectors® offer the industry's best value and performance for non-contact measurement. The mainstay of shop-floor measurement, optical comparators' tough construction and big viewing screens make measurements fast and easy. All OGP comparators use cutting-edge optical, lighting, and automation technologies, allowing for tight tolerances and a wide range of manufacturing process applications.

### OPTICAL SENSORS/ACCESSORIES



Contour Projectors offer many accessory options. Visit [ogpnet.com/ContourProjector](http://ogpnet.com/ContourProjector) for details.



Focus



QL-20™

## HIGHLIGHTS

### Internal Lens Turret

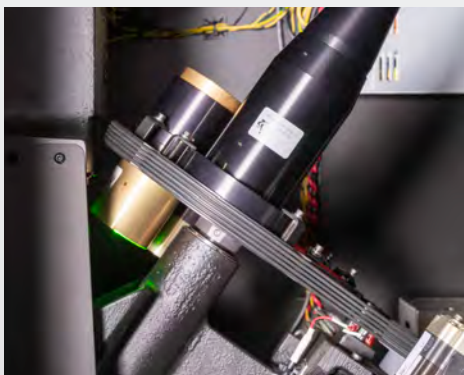

### Projectron Edge Detection

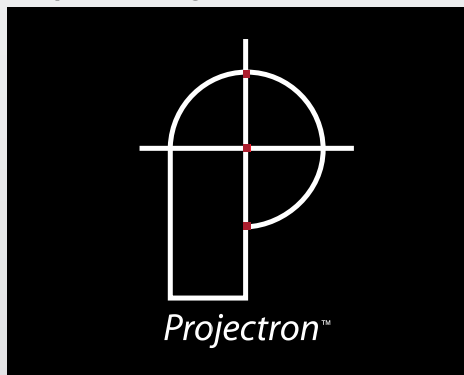

### TruLight® LED Illumination

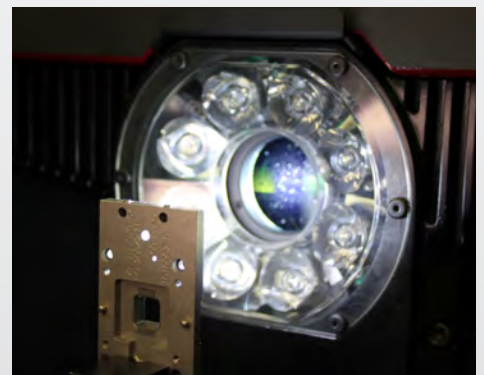

## LED ILLUMINATION



Profile Illumination 10x

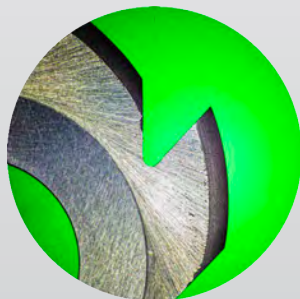

Surface Illumination 10x

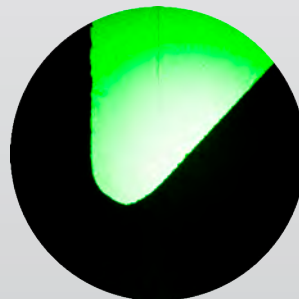

Profile Illumination 50x

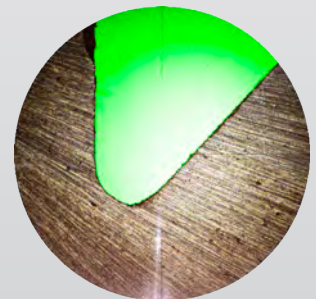

Surface Illumination 50x



## VIDEO CONTOUR PROJECTORS – C-VISION



A system that combines the speed and accuracy of a video measurement system with the rugged capacity of an optical comparator to create the world's easiest-to-use shop-floor measuring tools.



# VIDEO CONTOUR PROJECTORS – C-VISION

## c-vision

**c-vision™** Video Contour Projectors® from OGP combine the speed and accuracy of a video measurement system with the rugged capacity of an optical comparator to create the world's best shop-floor measuring tools for 2D measurement. c-vision benchtop and floor models are built for large, heavy parts with a load capacity up to 350 lbs. c-vision systems come equipped with impressive capabilities such as a durable build, large screens for measurement versatility, innovative optics, long service life, and more, making it the perfect option for contour projection needs.

### OPTICAL SENSORS/ACCESSORIES



*c-vision systems offer many accessory options. Visit [ogpnet.com/c-vision](http://ogpnet.com/c-vision) for details.*



c-vision Lite



c-vision Benchtop



c-vision Floor Model

## HIGHLIGHTS

### Instantaneous Digital Mag Changes

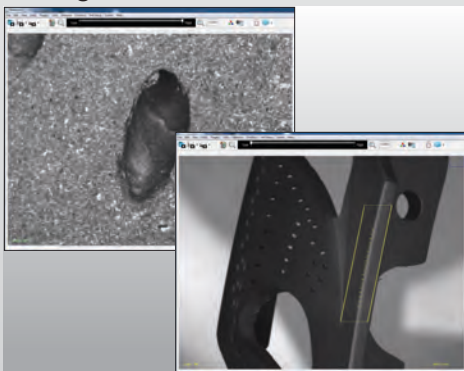

### Motorized Programmable Internal Lens Changer

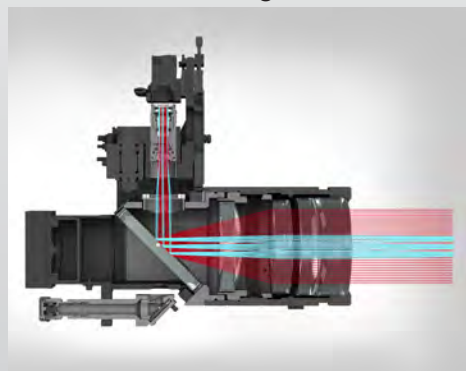

### 8-Sector Programmable Ring Light

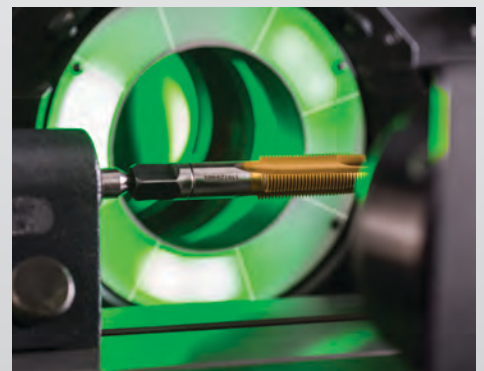

# 2D LARGE FIELD-OF-VIEW VIDEO MEASUREMENT SYSTEMS – SNAP



SNAP

Complex measurements made easy and accurate – it's as simple as placing a part on the stage and pressing go.





# 2D LARGE FIELD-OF-VIEW VIDEO MEASUREMENT SYSTEMS – SNAP

## SNAP

SNAP™ Video Measurement Systems are compact measuring systems that integrate perfectly from the shop floor, to the lab, or as part of an automated work cell. Rugged construction and an open work envelope make SNAP easy to implement in virtually any manufacturing setting.

SNAP systems use their unique fully telecentric large field-of-view (LFOV) optical system to measure small parts with fine features. Combined with a megapixel camera, SNAP optics produce high accuracy, low distortion images. Benchtop systems are compact units with an open work envelope while floor model systems offer expansive XY stage travel to measure dimensions of large parts or numerous small parts. SNAP systems come standard with motorized stages and all LED profile, coaxial, and 8 sector ring light illumination.

### OPTICAL SENSORS/ACCESSORIES



Visit [ogpnet.com/SNAP](http://ogpnet.com/SNAP) for details.



SNAP 100

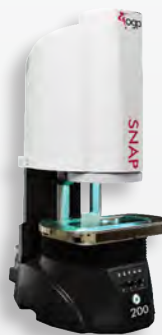

SNAP 200



SNAP 300



SNAP 350

## HIGHLIGHTS

### Telecentric Optics



### SnapShot™ Instantaneous Measurement

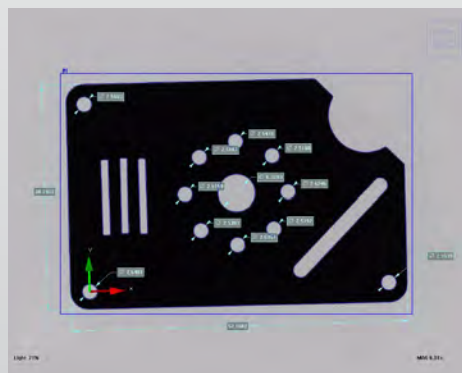

### Large Field-of-View (LFOV)

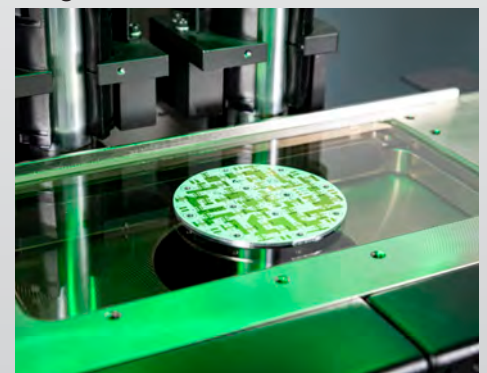

# SEMI-AUTOMATIC ZOOM VIDEO MEASUREMENT SYSTEM – STARLITE

Compact, 3-axis semi-automatic measuring system that is reliable, accurate and easy to use.





# SEMI-AUTOMATIC ZOOM VIDEO MEASUREMENT SYSTEM – STARLITE

## StarLite

The **StarLite™** 150 system combines versatile zoom optics with a digital color camera and an easy-to-operate stage, for the ultimate in simplicity. Fully automatic software guides the operator to position the stage to each measurement location where the programmed detection measurement tool(s) automatically measure the part feature.

### OPTICAL SENSORS/ACCESSORIES



Visit [ogpnet.com/StarLite](http://ogpnet.com/StarLite) for details.



StarLite 150

## HIGHLIGHTS

### VectorLight™

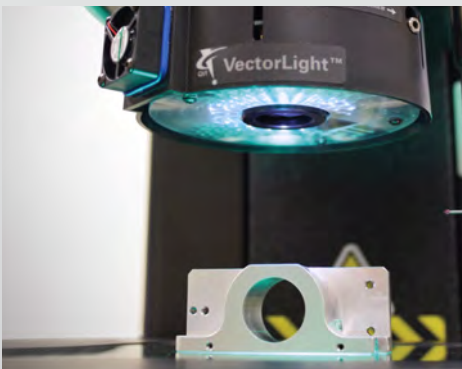

### Small Features Made Large

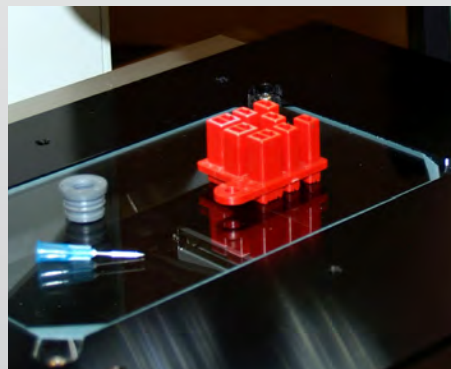

### Ergonomic Controls



Specialized systems include flexible measuring systems, non-contact laser profiling systems as well as non-contact, self-contained laser systems.



## FlexGauge

Itaca FlexGauge systems offer flexibility for users who need measuring systems and software for small, high precision parts or families of parts. Itaca FlexGauge provides performance advantages and cost savings when compared to traditional hard gauging systems. FlexGauge systems are designed to provide fast, accurate measurements on the manufacturing floor. A rugged alternative to custom gauging systems.

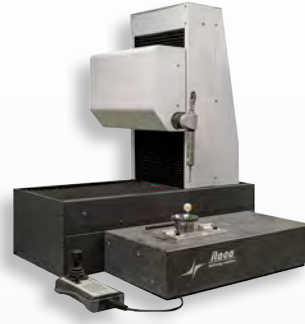

FlexGauge C-Series



FlexGauge T-Series

TACTILE PROBES



Visit [ogpnet.com/FlexGauge](http://ogpnet.com/FlexGauge) for details.

## Lazer

Lazer systems are benchtop systems that utilize the DRS Laser for scanning in 3 axes. Based on the Flash 200 elevating bridge platform, Lazer systems include an on-axis video camera allowing use of image processing tools to accurately measure datum targets and fiducials, and choose a specific measuring location/position.



Lazer 200

OPTICAL SENSORS/ACCESSORIES



Visit [ogpnet.com/Lazer](http://ogpnet.com/Lazer) for details.

LASER SENSORS



## Cobra

Cobra™ Laser Profiling systems use low-power laser lights to measure height, area, slope, and radius. These laser profilers are ideal for a variety of applications where non-contact measurement is critical to ensure integrity for your parts while measuring to precise accuracies.



Cobra 2D



Cobra 3D

LASER SENSORS



Visit [ogpnet.com/Cobra](http://ogpnet.com/Cobra) for details.

The world's most comprehensive metrology software presents a totally new way of working with multisensor measurement systems and provides faster, easier, and more productive measurements than ever before.

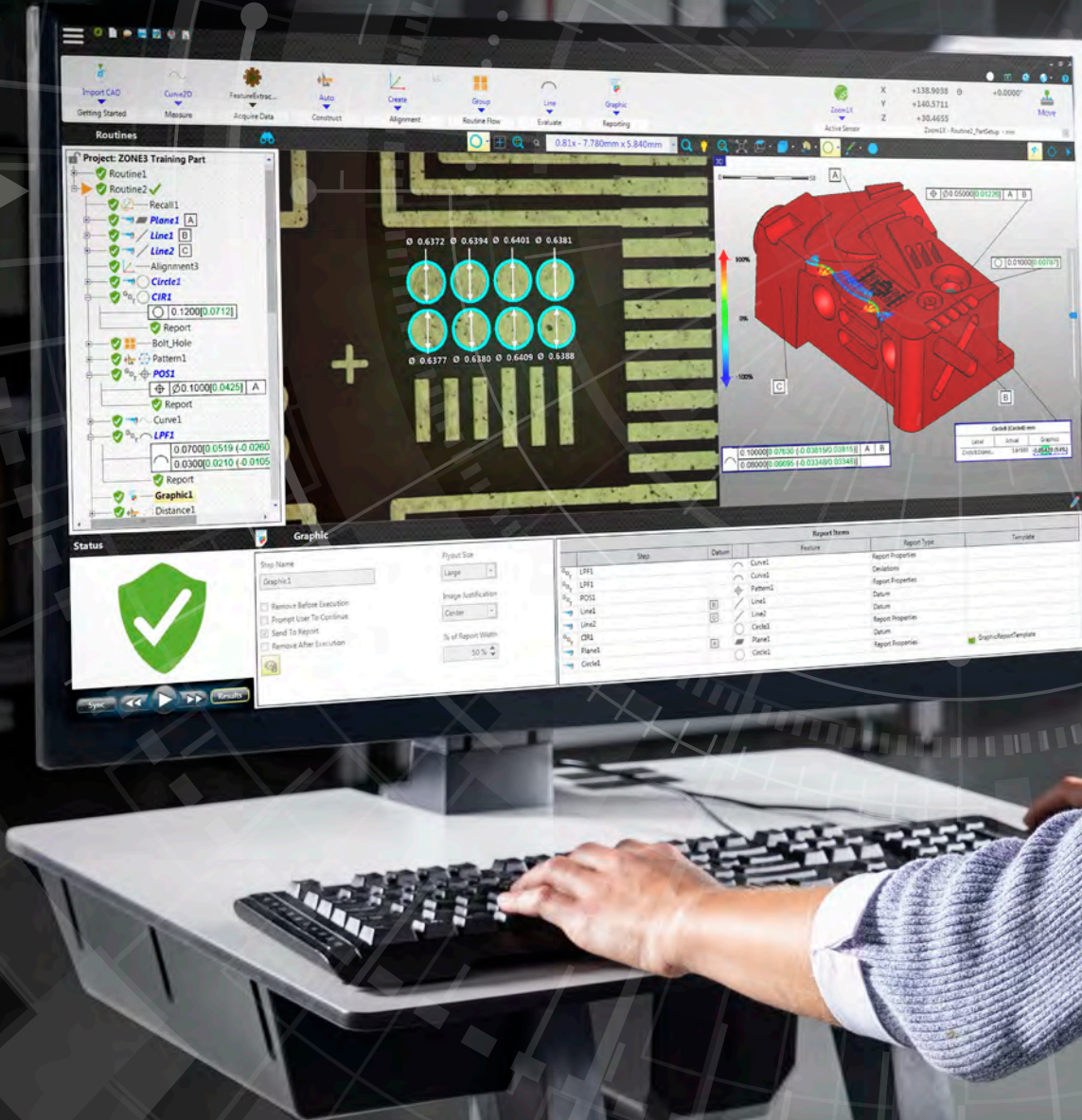



# METROLOGY SOFTWARE – ZONE3

## ZONE3

ZONE3 metrology software puts the power of OGP's 30+ years of multisensor experience into your measurement system for faster, easier and more productive measurements than ever before.

- **ZONE3 is fast.** Synchronous, full field image processing and high-speed cameras allow entire scenes to be measured instantly.
- **ZONE3 is capable.** Full multisensor capability, including scanning laser and scanning probe support, GD&T and custom scripting.
- **ZONE3 is easy to learn.** Regardless of which member of the ZONE3 family you use – Express, Prime, Pro or Offline – alignments, measurements and constructions are shown graphically in real time.
- **Offline programming** of any sensor allows parts to be continuously measured while new programs are written. The same procedures are used for all sensors. Learn one, you've learned them all.

### Advanced Video Tools

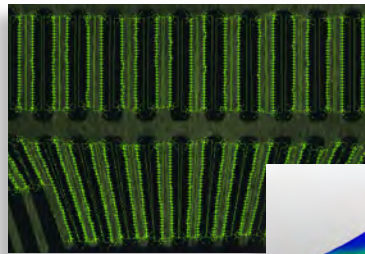

Parallel Processing

Area Multi-Focus

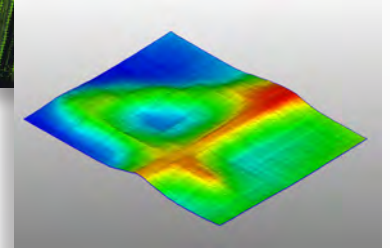

### Manual Measurement

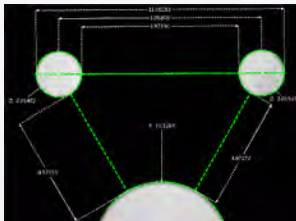

Use manual targets to make quick and easy walk-up measurements.

- No need to set up a part or import a CAD file.
- Manual measurements can be read directly off the DRO.

Use **FeatureExtractor** to automatically identify and measure features visible within the FOV.

- With one click, all prominent features are displayed as flyouts in the video window.
- Interactively hover over features to see relationships to other geometries.

### Automatic Edge Analysis Tools

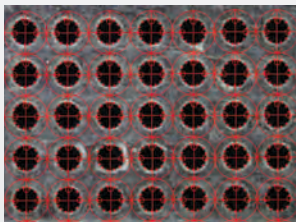

**FeatureFinder**<sup>®</sup> enables you to measure practically any kind of edge quickly and easily. When you select an edge from the video image, it automatically finds the points along the selected geometric shape (line, arc or circle), performs all the edge analyses, and displays the measurements.

**Parallel Processing** combined with intelligent routine **Optimization** allows the simultaneous measurement of as many features as can be seen.

### Visual Validation: Guiding You Through the Measurement Process

ZONE3 previews offer visual validation of each operation before it's executed. You get immediate visual feedback so common errors and unintended consequences are avoided.

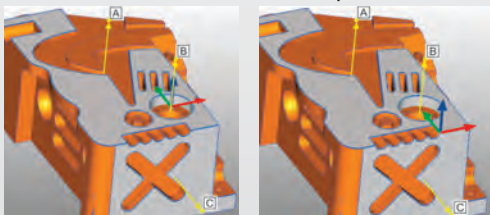

**Two different outcomes** based on the user's selection of Datums A-B-C (left), or A-C-B (right).

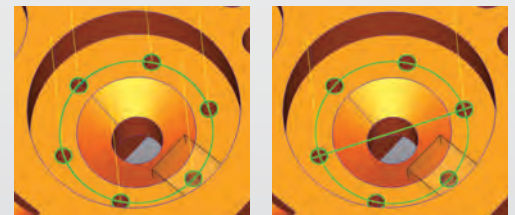
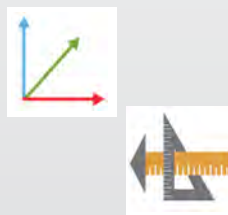

**Constructions** of bolt hole circle and maximum distance between two holes in that circle.

### Path Generation

ZONE3 AutoPath uses CAD nominals to automatically create an optimal path for each measurement. AutoPath is fully multisensor capable. Use AutoPath with any sensor.

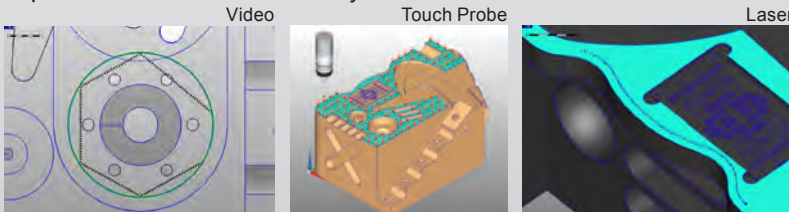

### Reporting

- ZONE3 recognizes ASME Y14.5 and ISO 1101 standards for GD&T.
- Animated tolerance zones\* allow you to visualize the specified tolerance condition.
- Specialized modules are available for Roughness, Gear, and Thread Evaluation
- Results can be output to PDF, Excel, or graphically to truly visualize the result.

\*US Patent Number 8 793 097 B2

## EVOLVE Software Suite

The **EVOLVE**® software suite from OGP optimizes design, production and inspection processes enabling manufacturers to shorten product design and development time, improve quality, and reduce costs through improved efficiency. EVOLVE uses a part's three dimensional CAD model as the basis for all tolerance evaluations, statistics and manufacturing data.

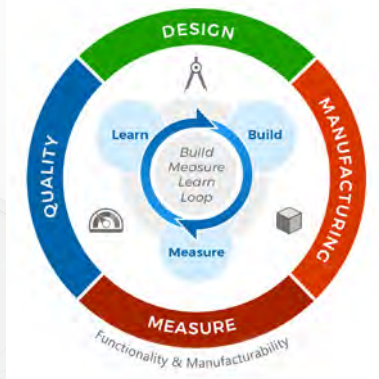

### BENEFITS

One understanding and consistent use of the language of Geometric Dimensioning and Tolerancing (GD&T) and Geometrical Product Specification (GPS).

Designers get assistance and help directly in the model they are working on.

Reduce rework costs of design changes by getting them right the first time.

One standards rules engine for all users reduces uncertainty from differing software algorithms.

Seamlessly move models downstream and upstream.

Normalize inspection processes with hardware independent software.



**EVOLVE Design** is Computer-Aided Engineering (CAE) tolerancing software that helps design engineers apply GD&T (GPS) tolerances to their CAD models correctly.

EVOLVE Design proofs GD&T (GPS) tolerances directly in the model. It highlights potential tolerancing problems and provides recommendations through explanatory systems that show relevant guidance based on the chosen GD&T (GPS) standard.

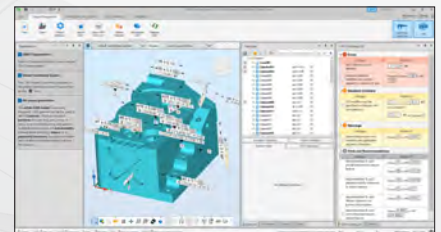

**EVOLVE Manufacturing** helps identify systematic problems with manufactured parts and recommends solutions to minimize manufacturing errors while improving the part design GD&T (GPS).

EVOLVE Manufacturing helps determine why a part has failed during the GD&T evaluation and which corrective actions can fix the manufacturing process to avoid future failures.

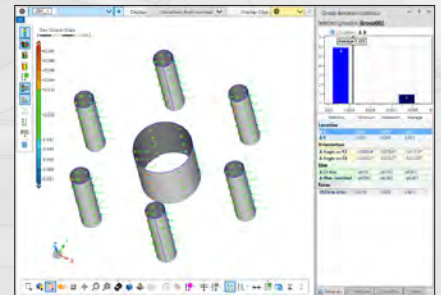

**EVOLVE SmartProfile**® from OGP is the world's leading dimensional analysis software. SmartProfile provides guidance for adding or modifying part design tolerances based on actual part inspection results. It combines measurement data with the CAD model of the part and automatically runs GD&T or GPS evaluations. Its rich set of tools allow engineers to analyze and solve complex manufacturing problems.

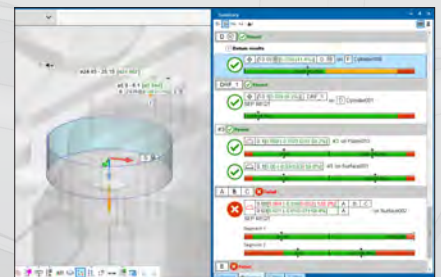

**EVOLVE SPC** is a full statistical process control software solution usable as a standalone product with existing measuring systems or integrated into the EVOLVE Suite.

Statistical information is presented in the 3D CAD model as tables and graphs of individual features or of the entire model, making it easier to see process variations by characteristic.

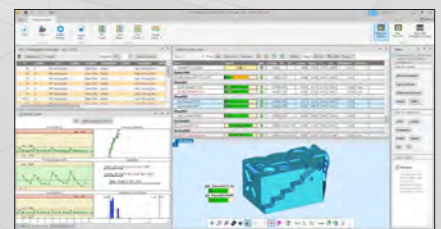





## Technical Support & Field Service

OGP/QVS is the official factory technical support and service team for OGP in North America, headquartered in Rochester, NY. The OGP/QVS team's goal is to keep your systems operating in peak condition. There are skilled technicians located throughout the United States who are compliant with ISO/IEC 17025 requirements for field service and calibration.



## Calibration Lab

In order to maintain and further enhance our system's precision measurement capabilities, in 2020 OGP (QVS/QVI) developed and opened our own fully accredited Line Scale Calibration Laboratory. The depicted line scale calibration bench within that tightly controlled lab, has a Calibration and Measurement Capability Uncertainty (CMC) as low as **22 nm**, (officially per independent audit Q[22, .072L] with L in mm; 2400 mm total length) this line scale bench is of a "national lab" level capability available to our representatives and customers for the measurement of optical calibration artifacts. At the time of this writing, for line scale lengths longer than 314 mm, this CMC claim is smaller than that of the expanded uncertainty claimed by NIST itself. The line scale bench uses laser interferometry as well as tight measurement and control of temperature, pressure and humidity to achieve these extremely low uncertainties.

# THE OGP PRODUCT FAMILY

**SmartScope E7**



**SmartScope E45**



**SmartScope Flash 200**



**SmartScope Flash 302**



**SmartScope Flash 500**



**SmartScope ZIP 450**



**SmartScope ZIP 635**



**SmartScope ZIP 800**

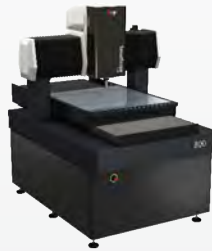

**SmartScope ZIP HR 250**



**SmartScope SP 332**



**SmartScope Quest 650**



**SmartScope Quest 800**



**Benchmark**



**Pinnacle**



**Summit**



**TurnCheck Series-6**



**TurnCheck Series-10**



**TurnCheck Series-14**



**ShapeGrabber Ai320**



**ShapeGrabber Ai620**



**c-vision Floor Model**



**SNAP 100**



**SNAP 200**



**SNAP 300**



**SNAP 350**





**SmartScope Flash 635**



**SmartScope Flash 670**



**SmartScope Flash 1500|1550|1552**



**SmartScope ZIP 250**



**SmartScope ZIP 300**



**SmartScope SP 463**



**SmartScope SP 663**



**SmartScope Quest 250**



**SmartScope Quest 300**

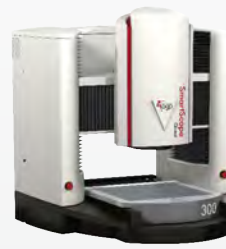

**SmartScope Quest 450**



**Fusion 400**



**Fusion 600**



**FlexPoint 7 Series**



**FlexPoint 9 Series**



**FlexPoint 12 Series**



**ShapeGrabber Ai820**



**Focus**



**QL-20**



**c-vision Lite**



**c-vision Benchtop**



**StarLite 150**



**Lazer 200**



**EVOLVE Suite**



## ADDITIONAL INFORMATION ABOUT OGP SYSTEMS

Explore a range of knowledge assets to help guide your research!

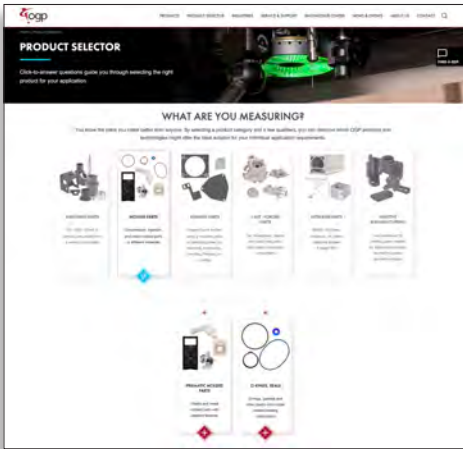

### Product Selector

This self-guided selector assists customers in identifying OGP products as a solution to their unique measurement needs.

Customers select what kind of parts they manufacture, what size the parts are, and the tolerances they need to meet – the Product Selector suggests a featured system and other recommendations based on the customer's input.



### Knowledge Center

Find numerous white papers, case studies, tech reports and other educational material about dimensional metrology and OGP product solutions.

You can also quickly learn about OGP technology and solutions by watching product explainer videos.



### ZONE3.zone

ZONE3.zone is the online community for ZONE3 users. Connect with fellow ZONE3 users and OGP Application Engineers to share metrology tips and get answers to your questions about ZONE3 features.



### Find a Sales Rep

OGP Authorized Representatives are metrology specialists, qualified to evaluate your measurement requirements and recommend the solution that best fits your needs.

Your local representative is ready to help you with product details, demonstrations, training, or purchase information.

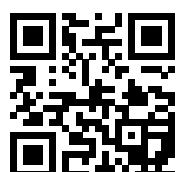

**World Headquarters:** Rochester, NY, USA • 585.544.0400 • [www.ogpnet.com](http://www.ogpnet.com)

**OGP Shanghai Co, Ltd:** Shanghai, China  
86.21.5045.8383/8989 • [www.smartscope.com.cn](http://www.smartscope.com.cn)

**OGP Messtechnik GmbH:** Hofheim-Wallau, Germany  
49.6122.9968.0 • [www.ogpmesstechnik.de](http://www.ogpmesstechnik.de)

**Optical Gaging (S) Pte Ltd:** Singapore • 65.6741.8880 • [www.smartscope.com.sg](http://www.smartscope.com.sg)

© 2023 Quality Vision International Inc. Specifications subject to change without notice. All rights reserved. Trademarks are the properties of their respective owners. Export of this product is controlled under U.S. Export Regulations. An Export License may be required for deliveries or re-export outside the United States. Part Number 794252-1223